

Electric tightening systems – Increased productivity and reliability

The system solution at a glance





Process: reliable Productivity: high

Increasing cost pressure, new customer requirements, and tighter regulations in an expanding number of industries – tackle any task with smart solutions from Rexroth! Our electric tightening systems combine all essential success factors for maximum process reliability and high productivity in your production line.

Controlled safety, reliable quality

Process control, accuracy and the highest level of functionality are critical components to every production and assembly line. The right screw must be tightened with the correct angle and the correct torque. Only then does an assembly reliably and securely meet the quality demands of the final product.

Requirements concerning tightening systems in the automotive industry are already clearly defined within the VDI/VDE 2862. Sooner or later there will be similar guidelines for safety and function critical applications for other sectors. Thanks to the accuracy of electric tightening systems from Rexroth and the possibility to document each and every assembly as well as compile statistics for quality assurance, you can rest assured that your process is reliable.

Increased productivity, cost-reducing energy efficiency

Electric tightening systems from Rexroth are deservedly considered state-of-the-art in tightening technology. Electric handheld tools for example enable accurate and reliable manual assembly. Electric tightening spindles provide short cycle times with a high degree of automation.

For those facing increasing energy prices, it is good to know that compared to pneumatic tools, electric tightening systems from Rexroth save up to 50 % of operating costs and more than 90 % of CO₂ emissions. Your investment in forward-looking Rexroth technology will pay off in just a few years.





Maximum flexibility

Today's customer demands create an increasingly complex business environment. In most areas of industry the number of product variants and speed of development continue to increase. New production processes need to be implemented more frequently and in a proactive way. To accommodate these needs, the modular design and flexible programming make Rexroth tightening systems the ideal solution.

The modular construction and common platform of handheld tools and tightening spindles enable your production to adapt to changes quickly and effortlessly. Fast and easy tool exchange during production is just as easy as the wireless data transfer or programming and controlling via a flexibly configurable operating system.

Tailor-made ergonomics

An ergonomically designed as well as highly productive work environment is a must for high performance production. With their user-friendly handling, the electric tightening systems from Rexroth tick all the boxes. Your employees will certainly think so.

The handheld nutrunners from Rexroth are all designed to provide comfortable handling and trouble free operation. Torque reaction is minimized through the use of software settings for start-up and shutdown behavior. The intuitive user interface of the operating system simplifies the control of the assembly process. In summary: With tightening technology from Rexroth you can optimize results and maximize the performance of your employees.

Prompt conversion, optimal deployment

Stricter guidelines for safety and function critical applications will present machinery and plant construction with more challenges in the near future. To date, the requirements of VDI/VDE 2862 have applied only to assemblies in the automotive industry. An extension to other industries is however already in progress.

Safety critical assemblies

Failure of a safety critical joint could endanger health or cause loss of life. It is for this reason that redundant monitoring as well as direct measurement of the tightening process is required. Each tightening cycle must be documented.

Function critical assemblies

Failure of function critical joints result in product failure. In these cases direct measurement in combination with indirect measurement of monitoring and control is required. Every fastening cycle must be documented.

Non critical assemblies

These assemblies are all cases not considered safety or function critical. A direct or indirect measurement can be used for the control of the fastening process.

Due to their accuracy and possibilities to document and analyze electric tightening systems from Rexroth take care of tomorrow's needs today. Thus your production is perfectly prepared for the directives to come.

02	Your benefits from Rexroth
06	Applications
08	Product overview
10	Selection matrix

12 Products

12 Tightening tools

12	Cordless WiFi nutrunners
16	Tightening spindles
20	Handheld nutrunners

26 Control and power electronics

26	Compact system
28	Modular system
32	Interface modules
34	Cables

36 Operating system

38 Customer-specific solutions

40 Services

40	Service
42	Training



The ideal tightening system for every application



Handheld nutrunners

- ▶ Ideal for small quantities
- ▶ Highest level of flexibility, accommodating frequent product changes or allowing access to hard to reach tightening positions
- ▶ Numerous variants are possible, easily expandable



Hand-guided tightening tools

- ▶ Ideal for applications where automatic positioning is not feasible due to complexity
- ▶ Variety of handling equipment available such as ergonomically designed mounts and support systems to absorb torque reaction
- ▶ Options include multiple spindle solutions such as for cycle time requirements or synchronized tightening

Be it handheld, hand-guided, semi or fully automatic: The electric tightening systems from Rexroth offer the efficient and safe solution for even the most diverse tasks and requirements in your production process.



Semi-automatic tightening station

- ▶ Ideal for complex multi spindle applications where a fully automatic approach is not appropriate
- ▶ Provides protection for operators via two-hand start, protection grating and light curtain

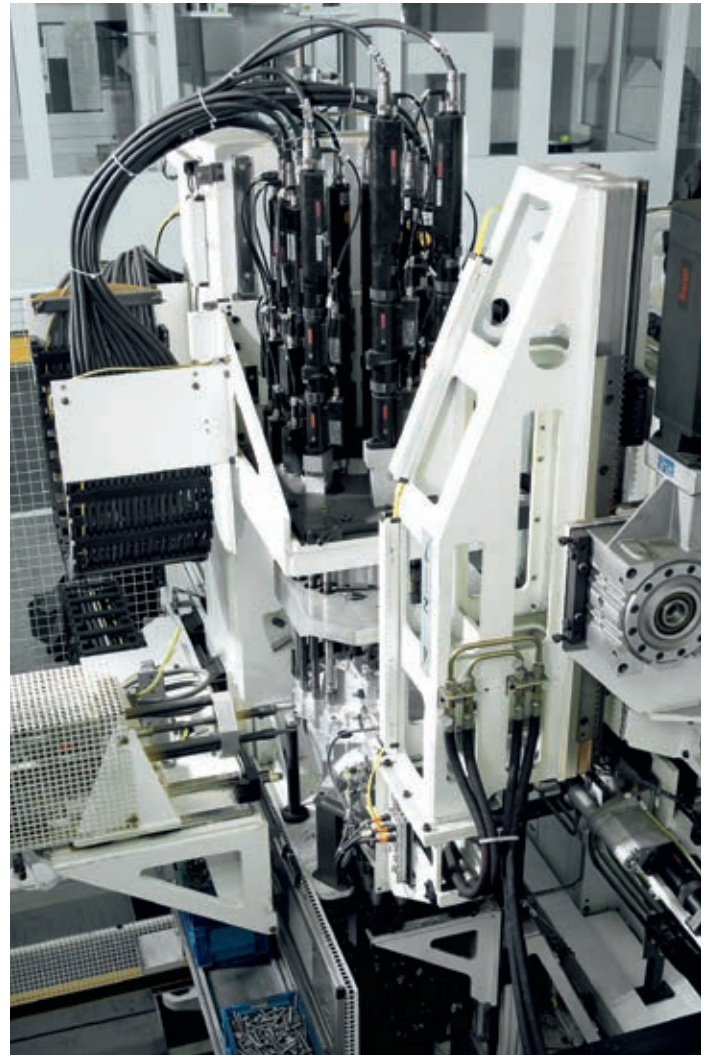

Fully automatic tightening station

- ▶ Highest level of automation for high speed and high volume production
- ▶ Tightening station with automatic bolt feed and part transfer, no operator needed
- ▶ Enables complex tightening processes with integrated rework

Smart, flexible, reliable: Tightening technology from Rexroth

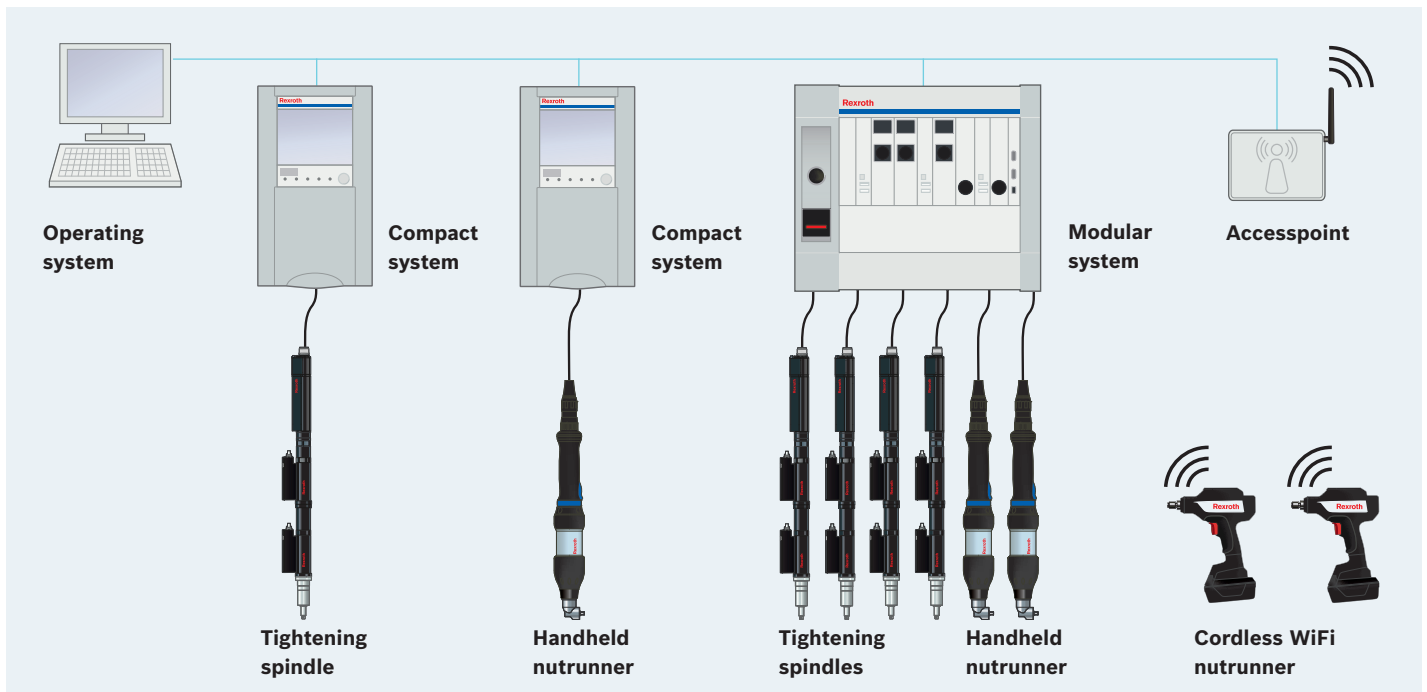

Cordless WiFi nutrunner

- Smart and safe tightening tools for the highest flexibility
- ▶ The highest degree of process reliability due to transducerized torque and angle monitoring
 - ▶ Reliability via integrated control and power electronics in conjunction with process reliable data storage
 - ▶ Work is made easy even at hard to reach areas
 - ▶ Information for operators is visible via a clear display



Tightening spindles

- Versatile and modular, configurable for a wide range of applications
- ▶ The highest level of reliability is met with redundancy measurements conforming to VDI standards
 - ▶ High performance for the most demanding applications in either hand-guided or automated assembly systems

Rexroth is your answer to accurate tightening technology. For all essential assembly tasks in the various industrial sectors, it provides tools, control systems and related accessories – from smart cordless WiFi nutrunners, ergonomic handheld nutrunners, versatile tightening spindles to fully automatic tightening systems.



Handheld nutrunner

Powerful, easy to handle and easy to use

- ▶ The highest level of process reliability through accurate measurement of all assembly parameters and digital data transfer
- ▶ Reduced operator fatigue through ergonomic design and light weight construction
- ▶ Easy operation via user-friendly control and indicator elements



Compact systems

Reliable and easy to use single-channel controllers for handheld nutrunners or tightening spindles

- ▶ Display and status LED provide clear information for operators
- ▶ Easy programming via user-friendly operating system
- ▶ Protection class IP54, EMC level IV



Modular systems

Space-saving and economical multi-channel controller supporting up to six tightening channels for handheld nutrunners, tightening spindles or mixed operation

- ▶ Supports a wide range of communication protocols for flexible system integration
- ▶ Available as system box (IP54) or as control rack for switch cabinet
- ▶ Up to 40 tightening channels can be combined by linking multiple systems



Operating system

For intuitive programming of tightening processes

- ▶ Icon-based programming and intuitive interface make it easy to learn and easy to use
- ▶ Automatic detection of electronic components
- ▶ Transparent tightening case analysis due to intelligible graphic design

A system for individual tightening solutions



Which configuration suits which application?
Our selection matrix is the ideal tool to help you make the right choice for your production.

Product group	
Assembly category according to VDI/VDE 2862	Safety critical application Function critical application
Suitable control and power electronics	Compact system CS351 Compact system CC-CS351 Modular system SB- and BT356
Technical data	Operating system Torque range
Other properties	



	Cordless WiFi nutrunner Nexo	Tightening spindle	Handheld nutrunner ErgoSpin	Handheld nutrunner CC-ErgoSpin
	●	●	●	–
	●	●	●	●
	possible*	●	●	●
	–	–	–	●
	possible*	●	●	–
	NEXO-OS via Web-Browser	BS350	BS350	BS350
	2 - 50 Nm	0.6 - 1,000 Nm**	1 - 220 Nm	2.4 - 40 Nm
	<ul style="list-style-type: none"> - Requires no external controller - Data transfer via WiFi or mini USB - Can be connected to compact or modular system via integrated logic 	<ul style="list-style-type: none"> - Modular construction - True redundancy possible - Mixed operation with CC-ErgoSpin, ErgoSpin and Nexo is possible 	<ul style="list-style-type: none"> - Mixed operation with CC-ErgoSpin, tightening spindle and Nexo is possible - Ergonomic design for reduced operator fatigue 	<ul style="list-style-type: none"> - Mixed operation with ErgoSpin, tightening spindle and Nexo is possible - Ergonomic design for reduced operator fatigue

* The control and power electronics are already integrated into the Nexo cordless WiFi nutrunner. However, the connection to a compact system with integrated logic (IL) or to a modular system with IL is possible.

** Torques above 1,000 Nm www.lsa-control.com comercial@lsa-control.com (+34) 960 62 43 01

● yes
– no

Nexo – Cordless WiFi nutrunner for maximum freedom

Rexroth Nexo is the solution for safety critical applications according to VDI/VDE 2862 and ensures maximum freedom in use at a consistently high level of process reliability! This is the first cordless WiFi nutrunner with already integrated control and power electronics enabling assemblies to be carried out in a process reliable manner even in silent zones. The integrated controller temporarily stores the tightening results and transfers them wirelessly to the receiving station at a later point in time.



- ▶ Its ergonomic design and maximum freedom of movement make it productive and easy to use
- ▶ Capital costs are reduced due to its easy integration and the elimination of additional control hardware
- ▶ Process reliable assembly: Temporary storage means no loss of data when working in silent zones
- ▶ No loss of cycle time due to stay-alive-function of 20 seconds during battery change
- ▶ Simple set-up via operator software in the web browser



Pistolgrip nutrunner

work is made easy even at hard to reach tightening positions

- ▶ Work area: 1.8 - 12 Nm
- ▶ Rotational speed: up to 1,500 min⁻¹
- ▶ Tool mount: quick-change chuck (1/4“)



Angle nutrunner

with slim angle head for easy access

- ▶ Work area: 4.5 - 50 Nm
- ▶ Rotational speed: up to 600 min⁻¹
- ▶ Tool mount: square drive (3/8“)

Nexo graphic display

- ▶ Good overview: Direct and clear indication of quality of assembly
- ▶ Information is reliably available regardless of position and wireless connection
- ▶ Fast, local parameter setting
- ▶ Extremely robust with low risk of injury owing to protective screen of impact resistant clear glass

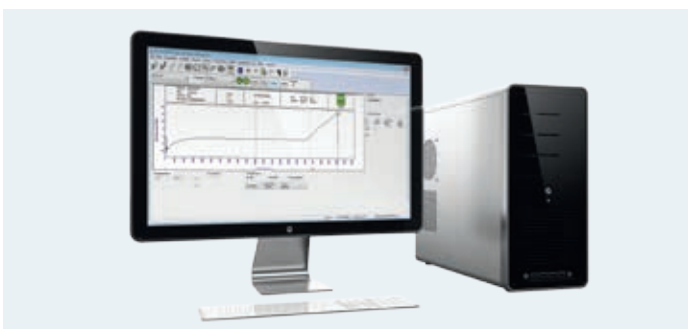

Browser-based operating software

- ▶ Easy set-up as additional software installation is not necessary. Operating software can be used without local installation
- ▶ Independence from end devices provides complete flexibility. Access to the browser-based software is not dependent on operating system nor end device
- ▶ Easy to learn, easy to use: Programming of individual tightening tasks is simple via the intuitive graphic user interface

Nexo – System integration

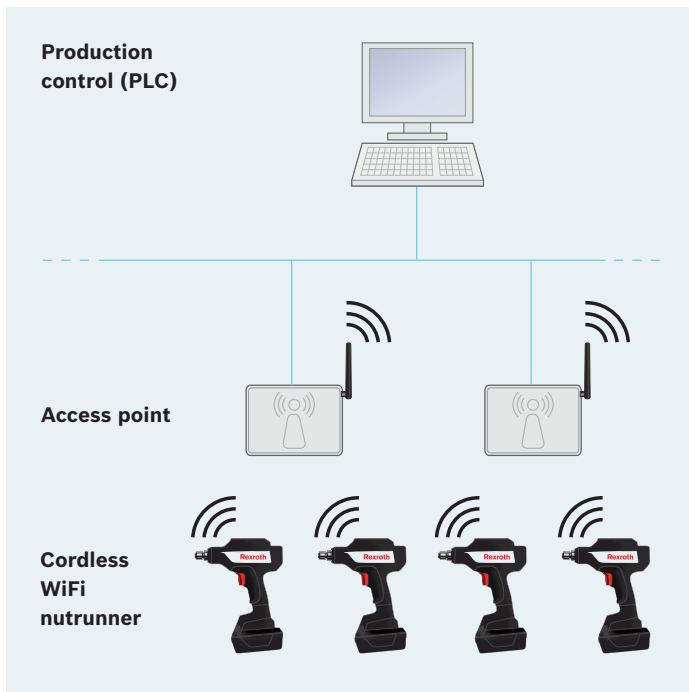

System integration of Nexo cordless WiFi nutrunners when using Ethernet-based production controls (PLC)

- ▶ The use of an additional control is not needed thanks to the integrated control and power electronics of the nutrunner. Advantages: Quick and simple set-up
- ▶ Use of standard access points in 2.4 and 5 GHz WiFi network: The integrated controller monitors the assembly during each cycle and transmits the results wirelessly to a standard access point
- ▶ Advantage: easy integration into the infrastructure of the production environment

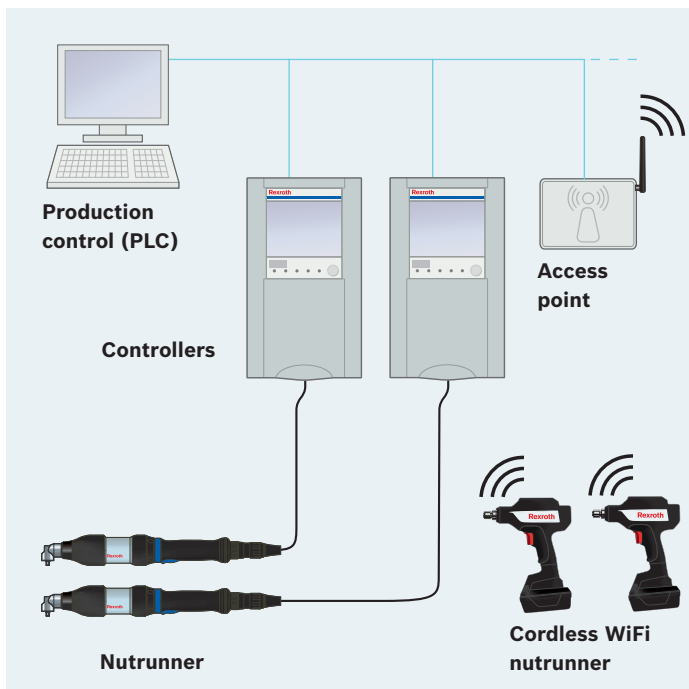

System integration of Nexo cordless WiFi nutrunners when using fieldbus-supported, higher-level production control (PLC)

- ▶ In addition to corded handheld nutrunners and tightening spindles, Nexo cordless WiFi nutrunners can be connected to variants of Rexroth tightening systems with integrated logic (IL)
- ▶ Current IL controllers can be retrofitted via an update for the operation of cordless WiFi nutrunners

Nexo – Accessories and extensions



Accessories and extensions for pistolgrip and angle nutrunners

- ▶ 36 V slide-in battery pack 2.1 Ah
- ▶ Single volt charger 36 V
- ▶ Access point to create wireless connection
- ▶ Programming adapter for commissioning and transfer of controller data without wireless connection
- ▶ MicroSD card to store configuration and result data
- ▶ Mixed colored rings (3 pcs per color) to use as a distinguishing feature



Accessories and extensions for pistolgrip nutrunners

- ▶ Suspension
- ▶ Holder
- ▶ Additional handle



Accessories and extensions for angle nutrunners

- ▶ Retrofit kit for battery assembly: Isolation and contact protection
- ▶ Holder
- ▶ Rotatable suspension

Tightening spindles – Modular and versatile for any application

Electronic tightening spindles from Rexroth are integrated into automated assembly stations or manual handling devices due to their high precision and efficiency – maximum process reliability with minimum waste. The modular construction allows them to be adapted easily and ideally to the particular tightening application. Depending on the configuration, they ensure safety as well as function critical assemblies according to VDI/VDE 2862.

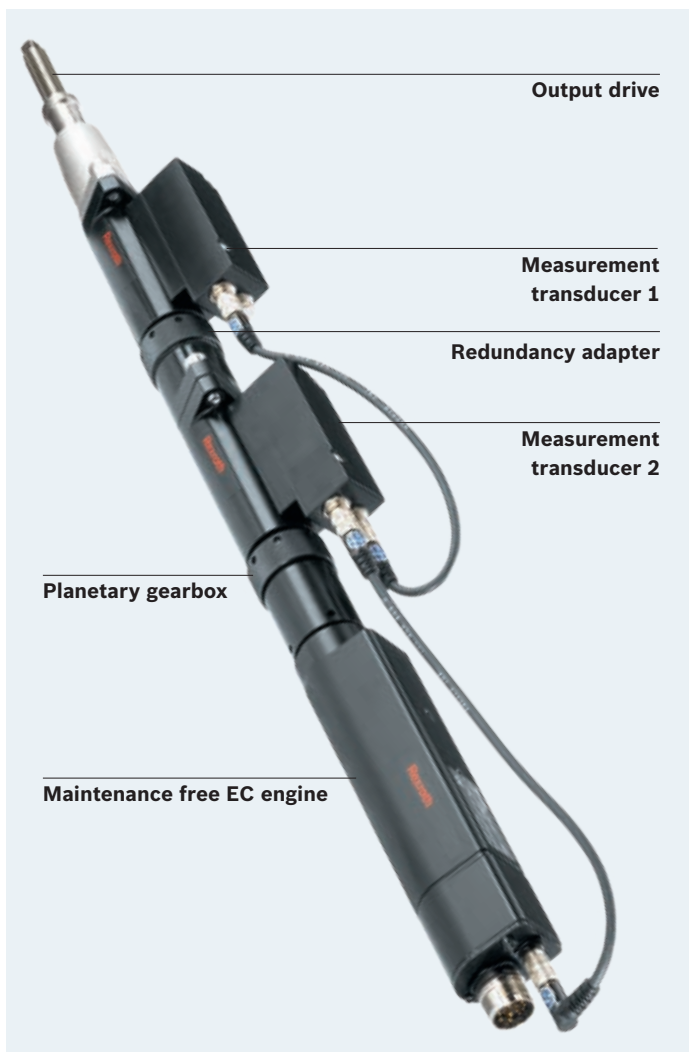

- ▶ Modular construction for an ideal adaptation to the application
- ▶ Maintenance free for 1 million full load cycles for long service life
- ▶ Process reliability and waste minimization through
 - Possibility of real redundancy measuring
 - Digital transfer of measurement values
 - Highest level of accuracy

Highest level of flexibility in tightening spindle configuration – here are some combinations of the many possibilities:



Tightening spindle with spindle bearing and redundant measurement transducer

- ▶ Easy installation
- ▶ Extended system protection
- ▶ Consistently modular principle for highly flexible production system
- ▶ Individually extendable



Tightening spindle with angle head

- ▶ For optimum accessibility
- ▶ Also available with integrated measurement transducer



Tightening spindle with offset output drive

- ▶ Multi spindle combinations with short distances between tightening positions
- ▶ Also available with integrated measurement transducer



Tightening spindle with transverse gear box

- ▶ Short length
- ▶ Available for all sizes

Tightening spindles – Configuration options

No matter in which work area between 0.6 and 1,000 Nm you wish your applications to take place, or if you wish to work with a spindle bearing, offset output drive, feed output drive or angle head: the components from Rexroth enable you to assemble the tightening spindle tailored to your exact needs.

The offset output drive is also available with integrated measurement transducer. In addition, you can choose between working with one measurement transducer or also with a second redundant measurement transducer for extended system protection. Regardless of the output drive, two measurement transducers can always be placed in a spindle via adapter.

We offer the optimum spindle components for any requirement. You are guaranteed to find the perfect tightening spindle for your application.

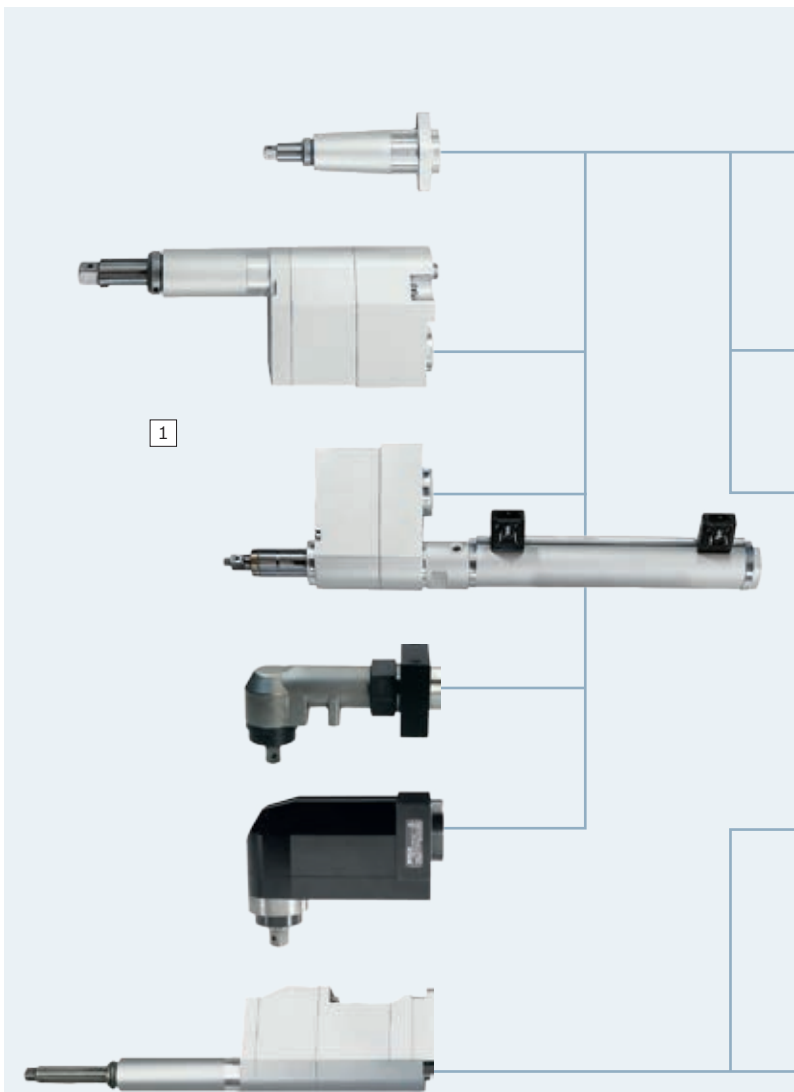

1 | Output drive



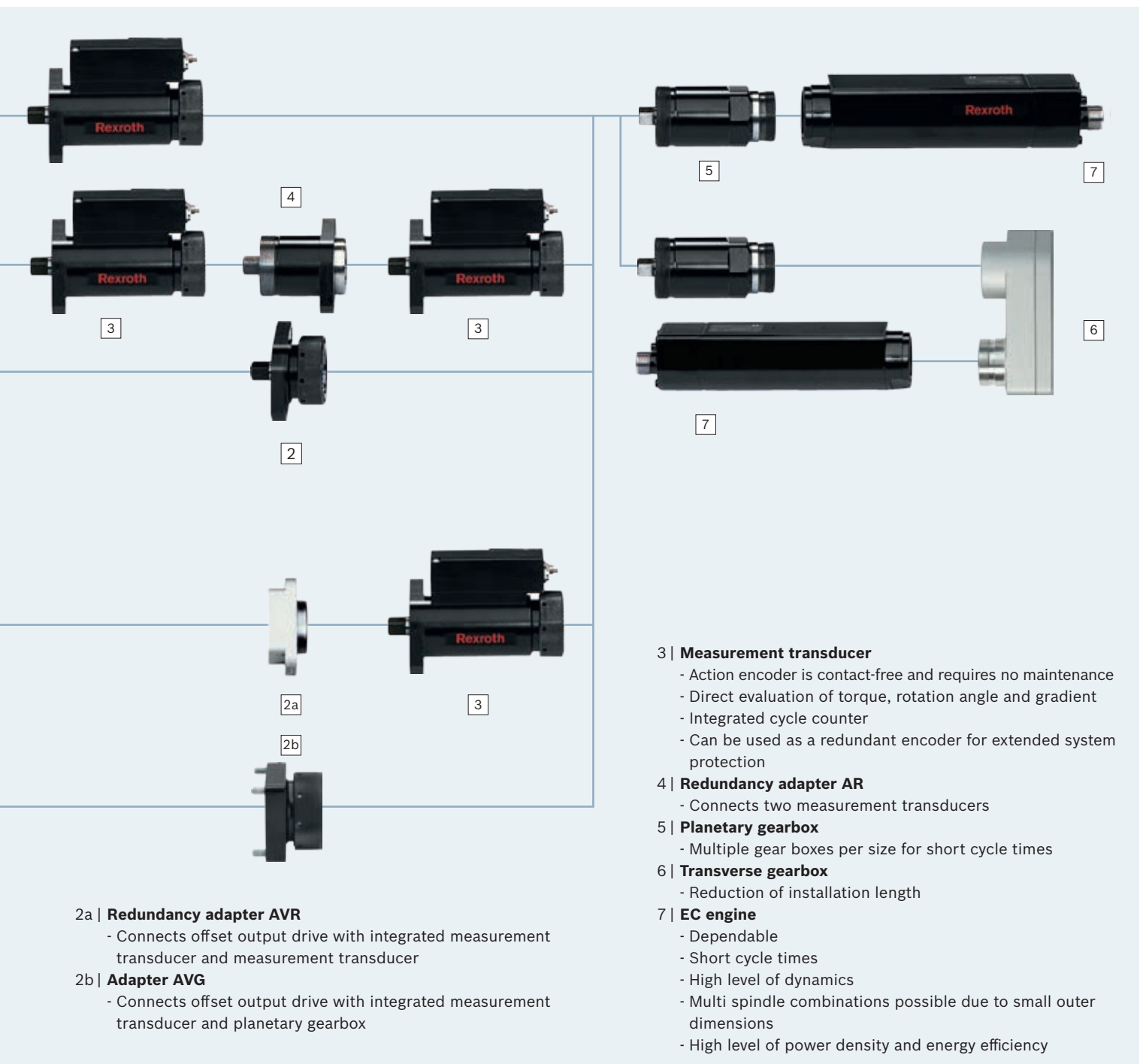

- The right output drive for every tightening position
- Specific output drives for increased radial force, e.g. for wheel nutrunners on request

2 | Adapter A

- Connects output drives and planetary gearbox during operation without measurement transducer



Tightening spindles – Output drive variants and technical data

The values below are a combination of torque (Nm) max. output speed (min ⁻¹). The Nm min ⁻¹ pairs are dependent on the combination of the tightening spindle configuration.				
Output drive variants	Frame size 2 (FS2) Nm min ⁻¹	Frame size 3 (FS3) Nm min ⁻¹	Frame size 4 (FS4) Nm min ⁻¹	Frame size 5 (FS5) Nm min ⁻¹
Spindle bearing 	0.6 - 5.5 1,000 1.2 - 10 1,000	1.7 - 16 740 6 - 32 740 6 - 35 295 6 - 55 295	6 - 52 1,000 6 - 56 340 15 - 150 340	50 - 150 515 50 - 500 145
Offset output drive 	0.6 - 5 1,000 1.2 - 10 1,000	1.7 - 14.5 740 6 - 29 740 6 - 35 295 6 - 51 295	6 - 51 1,000 8 - 75 740 13 - 120 410 13 - 130 135 15 - 145 340 20 - 200 240 35 - 340 135	50 - 135 515 115 - 335 200 50 - 465 145 115 - 1,000 55
Offset drive output with integrated measurement transducer 		1.6 - 16 740 6 - 29 740 6 - 33 295 6 - 53 295	15 - 47 1,000 21 - 65 700 36 - 117 410 15 - 142 340 21 - 200 240 36 - 342 135	
Feed output drive 	0.6 - 5 1,000 1.2 - 7 1,000 1.2 - 10 1,000	1.7 - 15 740 6 - 20 740 6 - 30 740 6 - 53 295	6 - 47 1,000 6 - 51 340 15 - 136 340	
Angle head 	0.6 - 5.5 1,000 1.2 - 11 1,000	1.7 - 16 705 2.6 - 25 705 6 - 27 705 6 - 32 705 6 - 50 280 9 - 34 440 9 - 90 175	6 - 52 985 6 - 56 320 9 - 83 620 9 - 90 204 15 - 130 320 24 - 220 200	

Tightening spindles – Accessories



◀ **Feed gripper**



◀ **Block output drives**



◀ **Angle heads with counter bracket**



◀ **Angle heads for tightening spindles size 5**



◀ **Socket tray**



◀ **Support systems**



ErgoSpin – Handheld nutrunners for maximum reliability

With the ErgoSpin range Rexroth offers smart and practical tools in numerous variants for safety- and function critical assemblies according to VDI/VDE 2862. The ergonomic shape and light weight of all handheld nutrunners enable reduced operator fatigue. They are simple to connect and can be integrated into the Rexroth tightening system quickly and without problem.



- ▶ Fast commissioning
- ▶ Flexible storage: only one cable type for all variants
- ▶ The highest level of accuracy via digital data transfer
- ▶ Ergonomic handling via integrated, mechanical interface for torque reaction support systems
- ▶ Process reliability via clear indicator elements
- ▶ CC-ErgoSpin variant for function critical assemblies



Pistolgrip nutrunner ESM

with integrated bright LED for hard to reach tightening positions

- ▶ Work area: 2.4 - 35 Nm
- ▶ Rotational speed: up to 1,700 min⁻¹
- ▶ Tool mount:
 - Square drive (1/4", 3/8")
 - Quick-change chuck (1/4")
 - Square drive with zero-play spur gearing (3/8")



Angle nutrunner GripLine

with plastic-coated angle head as scratch and shock protection, which also doubles as a second handle

- ▶ Work area: 1 - 75 Nm
- ▶ Rotational speed: up to 1,000 min⁻¹
- ▶ Tool mount: square drive (1/4", 3/8", 1/2")



Angle nutrunner SlimLine

with slim angle head for easy access

- ▶ Work area: 1 - 220 Nm
- ▶ Rotational speed: up to 1,000 min⁻¹
- ▶ Tool mount: square drive (1/4", 3/8", 1/2", 3/4")



Straight nutrunner VarioLine

with zero-play spur gearing for free connection of crowfoot wrenches and special output drives

- ▶ Work area: 1 - 146 Nm
- ▶ Rotational speed: up to 1,700 min⁻¹

ErgoSpin – Variants for safety and function critical assemblies



ErgoSpin – the perfect choice for safety critical assemblies

As failure of an assembly could endanger health or cause loss of life, particular precision is required at assembly. The ErgoSpin handheld nutrunner is equipped with high-precision electronic measuring technology. It ensures that assembly parameters are maintained within the smallest possible tolerances and any NOK assemblies (e.g. caused by faulty components or screws) are recognized immediately.

Even the toughest working conditions such as oily environments cannot adversely affect the highly accurate and robust ErgoSpin. It is tested in endurance runs with over a million assemblies under full load – without maintenance. The handheld nutrunner ErgoSpin is available for safety critical assemblies in the SlimLine, GripLine and VarioLine versions and as pistolgrip nutrunner.



CC-ErgoSpin – the all-rounder for function critical assemblies

Every production aims at high quality and efficiency. This is achievable through high-precision assembly tools. The current controlled CC-ErgoSpin enables a measuring accuracy and therefore a control over the tightening process not possible with conventional pneumatic nutrunners. This means less waste and less rework! Moreover, compared to pneumatic tools, energy costs are reduced by up to 90%. The cost-effective CC-ErgoSpin therefore ensures that acquisition costs will quickly pay for themselves.

Thanks to its ergonomic shape, the CC-ErgoSpin fits in the hand perfectly. Plus it is much quieter than a pneumatic tool. Its robust nature ensures a long service life. The CC-ErgoSpin for function critical assemblies is available in the SlimLine and VarioLine versions and as pistolgrip nutrunner.

ErgoSpin – Accessories, extensions and output drives



Accessories and extensions for angle and straight nutrunners GripLine, SlimLine, VarioLine

- ▶ Holder
- ▶ Rotatable horizontal suspension
- ▶ Vertical suspension
- ▶ Start lever extension incl. vertical suspension
- ▶ Lift lever enlargement for start button
- ▶ Extensions
- ▶ Adapter for the extension to a handling system
- ▶ Mounting aid for angle heads
- ▶ Torque support systems
- ▶ Scanner
- ▶ Angle heads for high torques
- ▶ Socket tray



Accessories and extensions for pistolgrip nutrunners ESM

- ▶ Socket tray
- ▶ Holder
- ▶ Suspension
- ▶ Additional handle
- ▶ Planetary gearbox for high torques



Output drives for straight nutrunners VarioLine

- ▶ Angle heads with square drive tool mount
- ▶ Angle heads for special output drives such as crowfoot wrenches
- ▶ Straight output drives with square drive or quick-change chuck tool mount for vertical nutrunner bits
- ▶ Output drive adapter for the combination of nutrunner with output drives from Rexroth tightening spindles

Compact system CS351 – User-friendly single-channel controller

The compact system CS351 is responsible for the control and amplification of the attached handheld nutrunner or tightening spindle. The CS351 is designed for safety critical applications, while the variant CC-CS351 handles function critical assemblies. A compact system can run one corded nutrunner. The user interface of the CS351 is easy to use and its extremely compact design saves space on the production line.

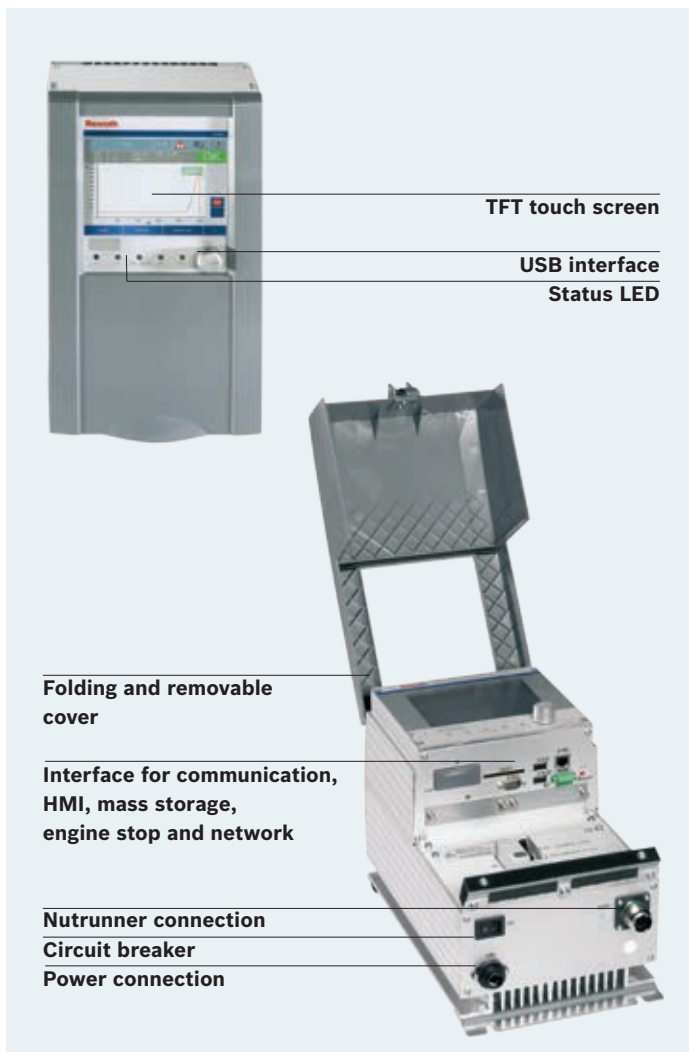

- ▶ Reliable and fast commissioning through clear system configuration
- ▶ Adapts flexibly to new tasks thanks to intuitive handling
- ▶ High level of durability: IP54, EMC level IV
- ▶ Standard- and Ethernet-based bus systems connect easily to external networks
- ▶ CC-CS351 variant for function critical assemblies

CS351E-x-xx and CS351S-x-xx

- ▶ Compact dimensions (H x W x D): 358 x 210 x 253 mm
- ▶ Robust aluminum housing
- ▶ Protection class IP54
- ▶ Easy assembly thanks to hanging racks
- ▶ Extensive interface portfolio for ErgoSpin or tightening spindle
- ▶ Voltage supply 120 V and 230 V
- ▶ Integrated ground fault circuit interrupter (GFCI)

**CS351x-G-xx**

Touch screen variant

- ▶ Resolution 640 x 480 px
- ▶ Actual value display
- ▶ Tightening curve display
- ▶ Parameter change and program selection

CS351x-D-xx

Display variant

- ▶ DVI interface for monitor and input device
- ▶ Actual value display

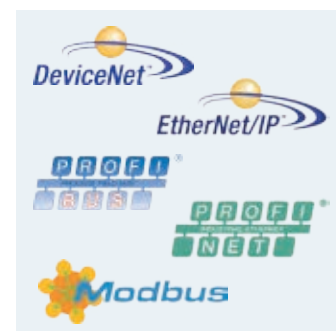
**CS351E-x-IL**

Variant with integrated logic

- ▶ Easy automation for the entire tightening task
- ▶ Programming in accordance with IEC 61131-3

CS351E-x-NK

Variant with network coupler

- ▶ Can be connected as an additional tightening channel
- ▶ Complete system bus diagnosis
- ▶ Central data output

CC-CS351E-D

Variant for CC-ErgoSpin handheld nutrunner

- ▶ Use for function critical assemblies

Interface variants

Available slots for different interface modules (field-buses, 24 V, mass storage) may be loaded as desired

Modular system SB356 and BT356 – Economical multi-channel controllers

Economical, reliable and extremely flexible in terms of the planning of production lines: The modular system from Rexroth for the control and power supply of your tightening tools. The modular system enables the mixed operation of handheld nutrunners and tightening spindles. Each modular system supports up to six tightening channels and as many as 40 tightening channels when combining multiple systems.



Power supply module for the power supply of the modular system

Control unit to control and monitor the tightening process

Servo amplifier for the power supply of the tightening channels

Communication unit for the coordination of multiple modular systems and external systems

Card rack with mounting brackets for the easy integration into a card control cabinet

Splash-proof system box (IP54) for operation without control cabinet

Plug-in modules for control, power supply and communication of modular system and tightening channels



- ▶ Mixed operation of tightening spindles and handheld nutrunners for a high level of flexibility in production line planning
- ▶ The compact design saves space (up to six channels per system; up to 40 channels are possible)
- ▶ Especially user-friendly thanks to the intuitive programming and easy installation
- ▶ System reliability via 100 % digital data transfer
- ▶ Safety of investment owing to scalability and extensibility on demand



System box SB356

- ▶ Compact dimensions (H x W x D): 600 x 510 x 470 mm
- ▶ Weight (unloaded): 55 kg
- ▶ Protection class IP54
- ▶ The innovative connector system makes assembly easy
- ▶ Voltage supply 3 x 230 V
- ▶ Integrated ground fault circuit interrupter (GFCI)



Card rack BT356

- ▶ Compact dimensions (H x W x D): 483 x 310 x 381 mm
- ▶ Weight (unloaded): 7 kg
- ▶ Assembly in the control cabinet or via mounting brackets to the mounting plate

Modular system – Plug-in modules



Power supply module VM350

for voltage supply in the card rack BT356 or in the system box SB356

- ▶ 24 V interface for voltage supply of KE, SE and LT in the case of power failure
- ▶ Motor stop interface
- ▶ 24 V supply for external loads



Control units SE352 and SE352M

for the control and monitoring of up to 2 tightening channels

- ▶ Fast and reliable commissioning through monitoring and identification of all individual components of a tightening channel
- ▶ Available slots for interface module IM24V (see accessories)



Servo amplifiers LTS350D and LTE350D

for the control of the EC motor

- ▶ Digital transmission of the control parameters from the control unit
- ▶ SE integrated motor protection for motor stop function



Communication units KE350 and KE350G IL

for the coordination of the control units

- ▶ Organization of interfaces to external systems for control and data exchange:
 - serial interface
 - three slots for different interface modules

Modular system – Accessories



Accessories

- ▶ Network coupler NK350S for the networking of individual system boxes and module racks as well as voltage supply of other network couplers
- ▶ Network coupler NK350S for the networking of individual system boxes and module racks
- ▶ Mass storage card



Interface modules

A detailed description of the available interface modules can be found on page 32 – chapter: interface modules.



Interface modules – Openness and flexible connectivity for compact- and modular systems

The interface modules from Rexroth provide the connection from the tightening system to the factory infrastructure. Due to proven Anybus approach, the modular interfaces from Rexroth are especially flexible and can be easily connected to external networks: The desired interface operates on the plug-in principle – modification to the tightening system itself are not required.

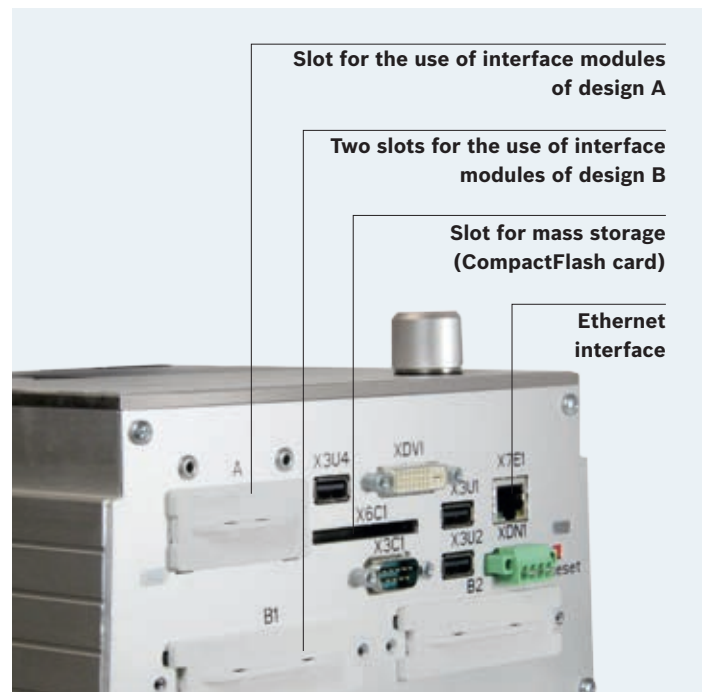
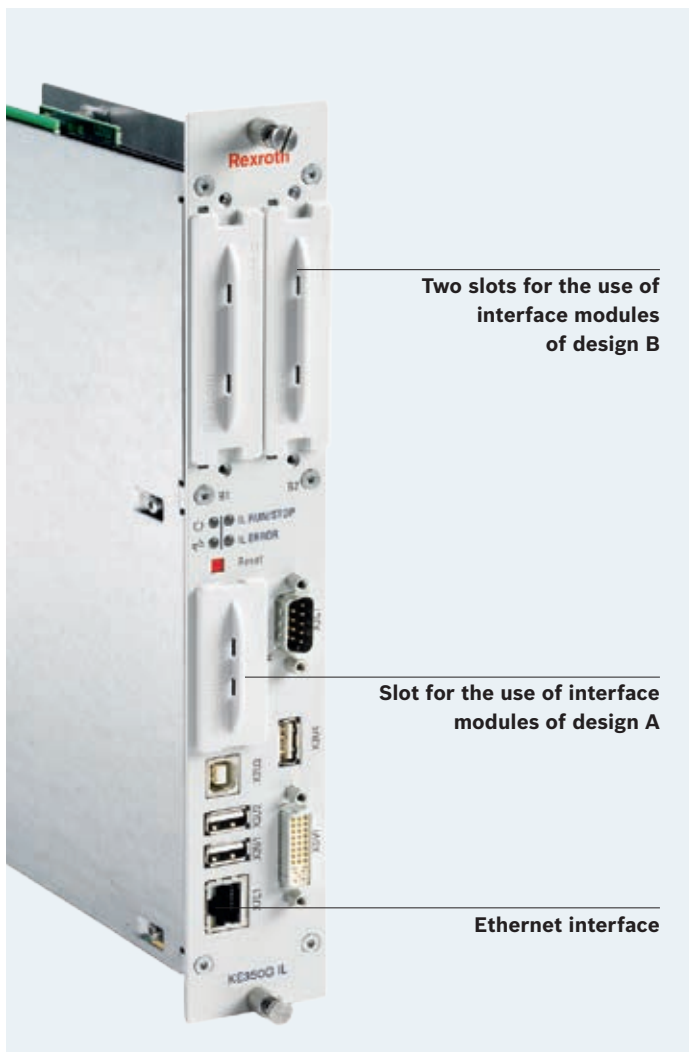

- ▶ Versatile interfaces for the highest level of flexibility (Ethernet, 24 V I/O, Ethernet)
- ▶ Anybus principle for easy connection of the tightening system to external networks
- ▶ The simple configuration of the interfaces enables fast commissioning and adaptations at a later stage

**IM24V**

- ▶ Enables the control of the tightening systems via a 24 V interface or the output from 24 V status signals from the tightening system
- ▶ Provides 10 inputs and 13 outputs
- ▶ Outputs are short-circuit proof and protected against reverse polarity
- ▶ Complies with DIN 19240

IMpnio

- ▶ PROFINET IO interface with IO device function (slave)
- ▶ Data transfer possible via the I/O level
- ▶ Meets the real-time classification (RT) of the PROFIBUS user organization
- ▶ Easily interchangeable with other fieldbus modules of the same type

IMpdp

- ▶ Enables the coupling of the tightening systems to the fieldbus PROFIBUS DP
- ▶ Data transfer possible via the I/O level
- ▶ Module has an address space of 512 bytes on the fieldbus
- ▶ Can be adjusted from 16 I/16 O points (4 bytes) to 512 I/512 O points (128 bytes) as well as 0 – 64 byte ID code

IMenip

- ▶ Complete EtherNet/IP interface with adapter function (slave)
- ▶ Data transfer possible via the I/O level
- ▶ Certified and tested for interoperability with leading EtherNet/IP scanner assembly groups
- ▶ Easily interchangeable with other fieldbus modules of the same type

IMdev

- ▶ Enables the coupling of the tightening systems to the fieldbus DeviceNet
- ▶ Data transfer possible via the I/O level
- ▶ Module has an address space of 512 bytes on the fieldbus
- ▶ Can be adjusted from 16 I/16 O points (4 bytes) to 512 I/512 O points (128 bytes) as well as 0 – 64 byte ID code

IMmtcp

- ▶ Complete ModbusTCP interface with server function (slave)
- ▶ Data transfer possible via the I/O level
- ▶ Easily interchangeable with other fieldbus modules of the same type

Cables – Continuous digital data and signal transfer

Cables guarantee the data communication as well as the voltage supply of the tightening tools within the tightening system from Rexroth. The highest level of accuracy and reliability in communication contribute significantly to process safety. Rexroth guarantees a consistently secure data and signal transfer via digital technology – control commands and measured values are thereby transferred and processed without interference.



- ▶ Secure and reliable data and signal transfer via digital technology
- ▶ Maximum cable length of up to 100 meters enables flexible hall planning
- ▶ Connection cable for tightening spindles are suitable for robot use
- ▶ Customer-specific cable lengths are available



- ▶ Connection cables to connect tightening spindles with compact- or modular systems
- ▶ Connection cables to connect handheld nutrunners with compact- or modular systems
- ▶ Extension cables to extend the connection cables of tightening spindles with compact- or modular systems
- ▶ Connection cables for ErgoSpin and spindles are suitable for robot use



- ▶ Network coupler cables to connect multiple modular systems



- ▶ Measurement transducer cables to connect the individual components of a tightening spindle



- ▶ USB programming cables to connect PC with compact or modular system
- ▶ Power supply cables to connect compact systems with a power socket (in Europe, included with delivery)

Operating software BS350 – Software environment for easy programming and analysis

Tightening systems from Rexroth are set-up with the operating system BS350. It enables the creation of tightening programs, analysis of tightening results, and provides comprehensive diagnostics through a convenient user guidance. The menu-controlled user interface with intuitive icons is easy to use, saving both time and effort.



- ▶ Fast commissioning thanks to intuitive menu design
- ▶ Automatic detection of the electronic components saves time and ensures error-proofing
- ▶ Easy entry of tightening process parameters
- ▶ Extensive selection of target- and monitoring functions for the adaption to individual tightening cases
- ▶ Evaluation possibilities on curves and statistics for process optimization

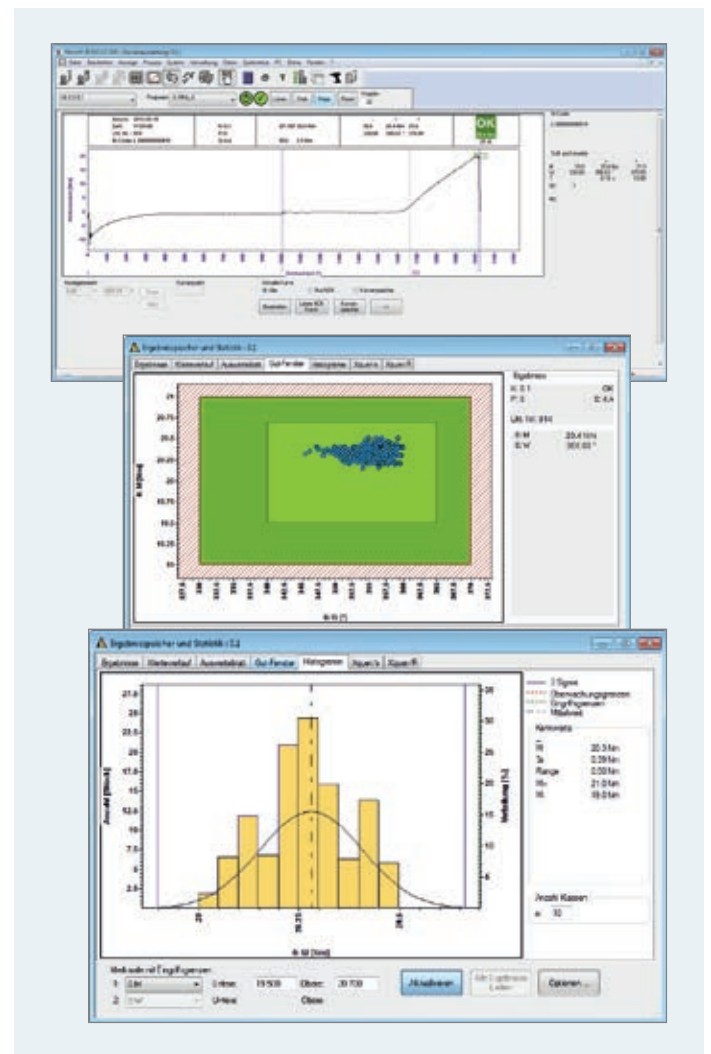
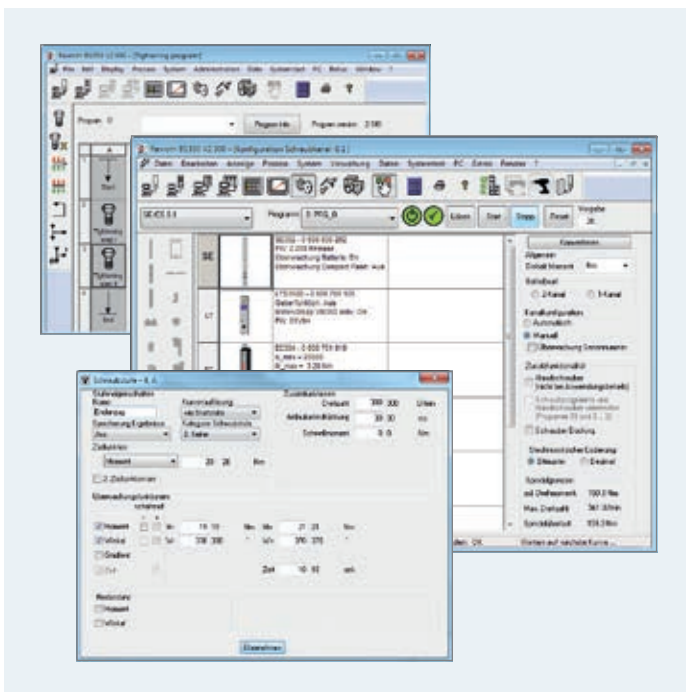

Programming

- ▶ System installation and programming of individual tightening tasks through comfortable, icon-aided tools
- ▶ Tightening processes are compiled on the graphic user interface
- ▶ Target- and monitoring parameters can be easily entered in the specified windows

Analysis

- ▶ Tightening graph to perform a quick tightening case analysis
- ▶ "OK" window with clear indication of the tightening results in the target window
- ▶ Bar chart for a quick overview of the statistical distribution of the tightening results

Customer-specific tightening solutions – Customized to your application

Precision and perfection do not only apply to the tightening systems from Rexroth, but also to their integration into customer-specific environments and requirements. You can rely on the extensive experience of the Rexroth tightening technology specialists. At your request, we can supply the complete work station around the tightening technology. We shall work with you and the machine manufacturers to achieve the ideal solution around your tightening tasks and ensure that all systems perfectly suit your needs.



- ▶ **Handling devices with torque support systems for tightening spindles and ErgoSpin handheld nutrunners**
- ▶ **Telescopic balancer with hand-guided tightening spindles thanks to low rolling resistance, ensure reduced operator fatigue**

- ▶ **Fully automatic tightening station – also with bolt feed – which are completely integrated into production lines**
- ▶ **Operator guidance and automatic solutions around the tightening position**

- ▶ Development and construction of complex work stations
- ▶ Integration of various technologies into an intelligent system
- ▶ Consideration of customer-specific requirements – tailored to the application

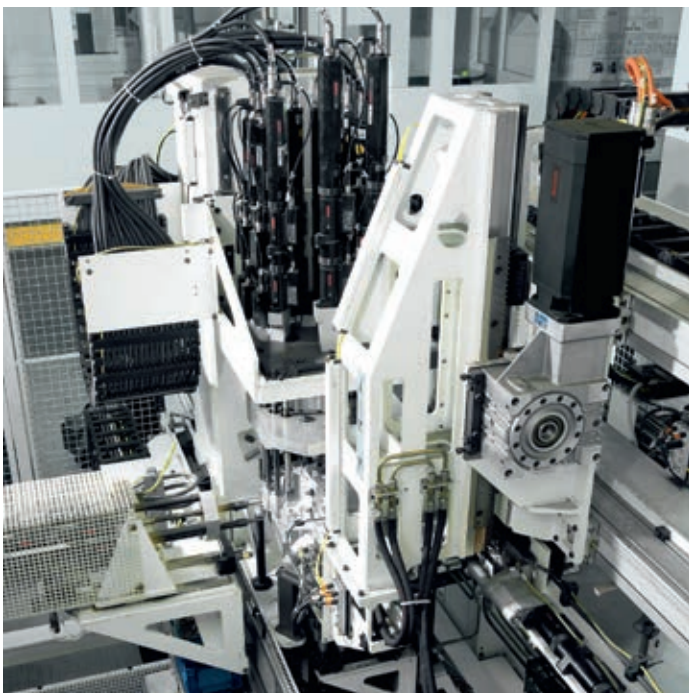

Service – Your key to higher productivity

Maximum plant availability and the highest level of efficiency over the entire live cycle of your machines and systems are decisive stroking levers for the productivity of your production. With its extensive services, Rexroth is able to support you in achieving your goal – worldwide and across all industries and machines.



Do you work with a variety of machines from different model years in your production? Do you require specialist knowledge about electric control and drive technology, hydraulics and mechanics? And you need someone with a deep understanding of the requirements of your industry? Then the service from Rexroth is your ideal partner.

The modular constructed service spectrum means a reduction in complexity and subsequently in cost of maintenance

and repairs of your production equipment. Our global service in over 80 countries means that we can be with you in no time to solve any problems thanks to the comprehensive know-how in all drive- and control technologies which Rexroth combines. We ensure fast diagnosis and short-term supply of spare parts. Operating efficiency is always at the forefront: In special workshops in your area, we shall repair and overhaul worn components and modules.

Moreover, we shall maintain your machine over its entire life cycle and adjust the efficiency to reflect the latest state of the art. Together with you, we shall analyze the potential of retrofit measures and implement them practically. We shall bring in line higher productivity with enhanced energy efficiency and standard safety. In addition, we shall make the benefits of condition-based maintenance accessible to you. This way, you can detect wear before it results in expensive machine downtime.



The service portfolio from Rexroth

- ▶ Consulting
- ▶ Spare parts service
- ▶ Field service
- ▶ Product overhaul
- ▶ Repair service
- ▶ Retrofitting

Further information available at:

www.boschrexroth.com/service

Training – Your access to further knowledge

As one of the world's leading specialists in drive- and control technology, Rexroth possesses unique technological know-how. We provide training on-site and via our Drive & Control Academy. We support customized training and further education as well as qualifying skilled personnel. Rexroth training in the area of tightening technology ranges from the provision of important basic knowledge to practical detailed training on the individual tool or system.



With its Drive & Control Academy, Rexroth offers an extensive portfolio of product knowledge, especially in the area of tightening technology. The training program is oriented towards the highest degree of practice and combines conventional and digitalized teaching- and learning methods. This ensures a tailor-made and highly effective implementation of staff training.

Most training includes practical exercises to consolidate theoretical knowledge. The training methods include face-to-face and hands-on training with personal contact, direct communication and especially the understanding of the components. The interaction of eLearning and face-to-face events – whether in preparation, during or after training or even eLearning on its own – enormously extends the set of methods with a variety of benefits.



The training offer from Rexroth in the area of tightening technology:

- ▶ The basic knowledge training offers a comprehensive introduction to tightening technology. Amongst other things, it presents the influencing factors of a bolted assembly in real tightening processes.
- ▶ During the trainings hardware, commissioning, programming of tightening systems, the participants get to know the hardware as well as the interaction of the individual system components. Practical programming exercises put into use what was learned in theory.
- ▶ The error diagnosis and recommissioning trainings put participants in a position to systematically and independently locate and remove errors.
- ▶ In addition, further specific training is always offered on new systems or tools, such as the Nexo cordless WiFi nutrunner.
- ▶ We do of course offer customer-specific training at our training center in Murrhardt or on-site at your company.

Further information available at:
www.boschrexroth.com/training

Bosch Rexroth AG

Fornsbacher Straße 92
71540 Murrhardt, Germany
www.boschrexroth.com

Find your local contact person here:

www.boschrexroth.com/contact

Further information:

www.boschrexroth.com/tightening

